

iCub

User manual

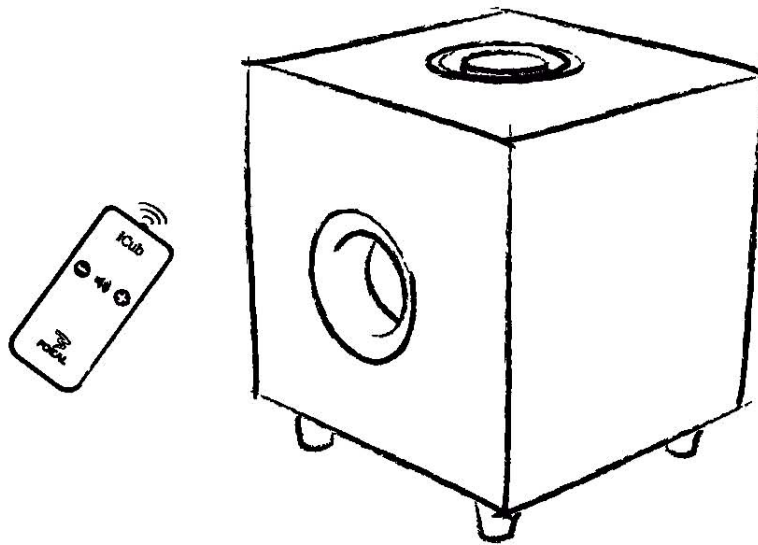

CONFORMITY

An example of this equipment has been tested and found to comply with the following European directives and international standards:
Electromagnetic compatibility EN 55103 / Electrical safety EN 60065

DÉCLARATION DE CONFORMITÉ

Un échantillon de ce produit a été testé comme étant en conformité avec les directives européennes et autres standards internationaux suivants :
Compatibilité électromagnétique EN 55103 / Sécurité électrique EN 60065



CE

FOCAL
the spirit of sound

Installation guide page: 11
Guide d'installation page : 19

Sib®, Sib XL®, Sib XXL® and iCub® are trademarks of Focal-JMLab®
Focal-JMLab - BP374 - 108, rue de l'Avenir - 42353 La Talaudière cedex - France - www.focal-fr.com
Tel. 00 33 4 77 43 57 00 - Fax 00 33 4 77 43 57 04 - ©Focal-JMLab - SCOS-041115/1

Important safety informations !

 <p>The light flash with arrowhead symbol, within an equilateral triangle, is intended to alert the user to the presence of uninsulated «dangerous voltage» within the product's enclosure that may be of sufficient magnitude to constitute a risk of electric shock to persons.</p>	<div style="border: 1px solid black; padding: 5px; text-align: center;"> <p>CAUTION RISK OF ELECTRIC SHOCK DO NOT OPEN</p> </div> <p>Caution : To prevent the risk of electric shock, do not remove cover (or back). No user-serviceable parts inside. Refer servicing to qualified service personnel.</p>	 <p>The exclamation point within an equilateral triangle is intended to alert the user to the presence of important operating and maintenance (servicing) instructions in the literature accompanying the appliance.</p>
<ol style="list-style-type: none"> 1. Please read the instructions. 2. You must keep these instructions. 3. You must also read the warnings. 4. Always follow all the instructions. 5. Do not use this appliance near water. 6. When cleaning, use a dry cloth only. 7. Do not block any ventilation openings. Always follow the manufacturer's instructions on how install the appliance. 8. Do not place the appliance near a heat source such as a heater, a cooker, a heating element or any other appliances (including amplifiers) that release heat. 9. Always carefully follow the safety instructions for the mains supply cord. The cord is made of two strips; one is wider than the other one. An earth cord is made of two strips, plus one for the earth connection. The wider strip or the third one is there for safety purposes. If the mains supply cord does not fit your mains supply plug, you must seek advice from an electrician and have the obsolete plug replaced. 10. Make sure that the supply cable cannot be tread on, squashed or pinched. Please act carefully with the supply pin and the connection between the cord and the appliance. 11. Only use the accessories recommended by the manufacturer. 12. Only use the lifting accessories, stands, tripods, trolleys or tables recommended by the manufacturer or use only those sold with the appliance. When using a trolley, you must be very careful when moving the appliance with this device in order to avoid any injuries that could be caused if it were to tip over. 	<ol style="list-style-type: none"> 13. You must unplug the appliance when there is a storm or if it is not being used for long periods of time. 14. Any service work must be done by qualified persons. Servicing is imperative after any damage such as damage of the cable or the supply pin, spilling of liquid, inserting objects inside the appliance, exposure to rain or damp, bad operation or if the appliance should fall. 15. Do not take any risks; do not use accessories that are not recommended by the manufacturer. 16. This appliance must be connected to the correct mains supply only, as indicated on the label of the appliance. If you have any doubt on the type of the mains supply of your electricity, you must seek advice from the supplier of the product or the supplier of electricity. For appliances supplied by a battery or any other supply, please follow the manual's instructions. 17. If an external aerial or a cable network is connected to your appliance, you must make sure that the aerial or cable are connected to the earth to guarantee protection against electrical surge and also the effects of static electricity. The information regarding the way of correctly connecting the pole to the earth, as well as the cable of the aerial, the section of the conductors, the position of the system of discharged, the connection, and the specifications of the electrode of the earth are contained in the Article 810 of the National Electrique, ANSI/NFPA 70. 	<ol style="list-style-type: none"> 18. An external aerial must always be kept away from high voltage wires or electric circuits. It must also be kept away from high-density lighting and places where it could fall on high voltage wires or an electric circuit. When installing an external aerial, please remember to avoid any contact with such circuits, as there may be a risk of lethal danger. 19. Do not overload wall plugs, electric extensions or multi plugs. Failing to do so may result in risks of fires and electric shocks. 20. You must not insert any kind of object in the ventilation openings of the appliance. Any kind of object could then be in contact with high voltage components or lead to a short-circuit and ultimately lead to a risk of fire or an electric shock. Do not spill any liquid on the appliance. 21. Do not attempt to repair the appliance yourself. When opening this appliance you may be exposed to hazardous tensions and other risks. For all interventions you must see a qualified person. 22. When it is necessary to replace components, please make sure that the technician uses the components recommended by the manufacturer or make sure that the components used have the same characteristics as the genuine ones. Using components that are not genuine may result in risks of fire, electric shocks or other risks. 23. After any service or repair, you must ask the technician to test the appliance to make sure it is safe to use. 24. The appliance must not be wall-mounted nor mounted on a ceiling unless it is specified by the manufacturer and according to the wires of the aerial.

A lire en premier!

Instructions de sécurité importantes!

 <p>L'éclair représenté par le symbole flèche et contenu dans un triangle équilatéral, a pour objet de prévenir l'utilisateur de la présence de tension élevée au sein de l'appareil pouvant entraîner un risque de choc électrique.</p>	<div style="border: 1px solid black; padding: 5px; text-align: center;"> <p>CAUTION RISK OF ELECTRIC SHOCK DO NOT OPEN</p> </div> <p>Attention: Afin de prévenir tout risque de choc électrique, ne pas enlever le capot (ou l'arrière) de cet appareil. Aucune pièce n'est remplaçable par l'utilisateur. Pour entretien ou réparation, veuillez contacter une personne qualifiée.</p>	 <p>Le point d'exclamation contenu dans un triangle équilatéral, a pour objet de prévenir l'utilisateur de la présence d'instructions importantes mentionnées dans le mode d'emploi et relatives à la mise en œuvre et à l'entretien de l'appareil.</p>
<ol style="list-style-type: none"> 1. Lire ces instructions. 2. Conserver ces instructions. 3. Prendre en considération les mises en garde. 4. Suivre toutes les instructions. 5. Ne pas utiliser cet appareil en présence d'eau. 6. Nettoyer uniquement avec un chiffon sec. 7. N'obstruer aucun orifice de ventilation. <p>Installer l'appareil en suivant les instructions du fabricant.</p> <ol style="list-style-type: none"> 8. Ne pas installer l'appareil à proximité d'une source de chaleur tel un radiateur, une cuisinière, une bouche de chauffage ou tout autre appareil (y compris les amplificateurs) dissipant de la chaleur. 9. Respecter les instructions de sécurité concernant le cordon d'alimentation secteur. Le cordon d'alimentation présente deux lames dont l'une est plus large que l'autre. Un cordon avec mise à la terre contient deux lames ainsi qu'une troisième pour la connexion à la terre. La lame la plus large ou la troisième lame ont pour objet d'assurer votre sécurité. Si le cordon d'alimentation ne s'adapte pas à votre prise d'alimentation secteur, consultez un électricien et remplacez la prise secteur défectueuse. 10. Assurez-vous que le câble d'alimentation ne puisse être piétiné, écrasé ou pincé. Une attention toute particulière doit être accordée à la fiche d'alimentation et à la liaison du cordon avec l'appareil. 11. N'utiliser que les accessoires recommandés par le fabricant. 12. N'utiliser que les appareils de manutention, pieds, trépieds, supports ou tables recommandés par le fabricant ou ceux vendus avec l'appareil. Lorsqu'un chariot est utilisé, redoublez de prudence lors du déplacement de l'ensemble chariot/appareil afin d'éviter toutes blessures par basculement. 13. Débranchez l'appareil en cas d'orage ou pendant de longues périodes pendant lequel l'appareil n'est pas utilisé. 	<ol style="list-style-type: none"> 14. Toute tâche de maintenance doit être réalisée par un personnel qualifié. Une maintenance est nécessaire à la suite de tout dommage occasionné à l'appareil tels que la détérioration du câble ou de la fiche d'alimentation, le déversement de liquide ou l'insertion d'objets à l'intérieur de l'appareil, l'exposition à la pluie ou à l'humidité, le mauvais fonctionnement ou le renversement de l'appareil. 15. Ne pas utiliser d'accessoires non recommandés par le fabricant de l'appareil afin d'éviter tout risque. 16. Ce produit doit être raccordé uniquement au type d'alimentation secteur indiqué sur l'étiquette figurant sur l'appareil. En cas d'hésitation sur le type d'alimentation de votre installation électrique, consultez le vendeur de votre produit ou votre fournisseur d'électricité. Pour les appareils prévus pour une utilisation à partir d'une batterie ou d'une autre source d'alimentation, se référer au manuel d'utilisation. 17. Si une antenne extérieure ou un réseau câblé est connecté à votre appareil, assurez-vous que l'antenne ou le câble soit raccordé à la terre afin de garantir une protection contre les surcharges électriques et les effets de l'électricité statique. Les informations relatives à la façon de relier correctement le mât à la terre, ainsi que le fil d'antenne à l'unité de décharge, la section des conducteurs, la position du système de décharge, la connexion et les spécifications de l'électrode de terre sont contenues dans l'article 810 de la norme National Electric, ANSI/ NFPA 70. 18. Une antenne extérieure doit toujours être tenue à l'écart des lignes haute tension ou des circuits électriques et d'éclairage de forte intensité ainsi que de l'endroit où elle serait susceptible de tomber sur de telles lignes haute tension ou circuits électriques. Lors de l'installation d'une antenne extérieure, un soin tout particulier doit être pris afin d'éviter tout contact avec de tels circuits, ceux-ci pouvant présenter un risque mortel. 	<ol style="list-style-type: none"> 19. Ne surchargez pas les prises murales, les rallonges électriques ou les prises multiples. Il pourrait en résulter incendies ou chocs électriques. 20. Ne jamais insérer un quelconque objet par les trous de ventilation de l'appareil. Il pourrait entrer en contact avec des composants soumis à de hautes tensions ou les court-circuiter et ainsi occasionner un incendie ou un choc électrique. Ne jamais répandre de liquide sur l'appareil. 21. Ne tentez pas de réparer cet appareil par vos propres moyens; l'ouverture de cet appareil peut vous exposer à des tensions dangereuses ou à d'autres risques. Pour toute intervention de maintenance, adressez-vous à un personnel qualifié. 22. Lorsque le remplacement de composants est nécessaire, assurez-vous que le technicien de maintenance utilise les composants spécifiés par le fabricant ou présentant des caractéristiques identiques à ceux correspondant à l'exemplaire d'origine. Des composants non conformes peuvent provoquer incendies, chocs électriques ou autres risques. 23. Après toute intervention ou réparation sur l'appareil, demandez au technicien de maintenance de procéder à des tests afin de vérifier que le produit fonctionne en toute sécurité. 24. L'appareil ne doit être monté sur un mur ou au plafond que si le constructeur le prévoit, et uniquement selon les Fil d'antenne



Bitte zuerst lesen!

Wichtige Sicherheitsmaßnahmen!

 <p>Das Blitzsymbol in einem Dreieck weist den Nutzer darauf hin, dass eine Berührungsgefahr mit nicht isolierten Teilen im Geräteinneren, die eine gefährliche Spannung führen, besteht. Die Spannung kann so hoch sein dass sie die Gefahr eines elektrischen Schlags bei Personen birgt.</p>	<div style="border: 1px solid black; padding: 5px; text-align: center; background-color: #f0f0f0;"> <p>CAUTION RISK OF ELECTRIC SHOCK DO NOT OPEN</p> </div> <p>ACHTUNG: UM SICH NICHT DER GEFAHR EINES ELEKTRISCHEN SCHLAGS, AUSZUSETZEN, DÜRFEN SIE NICHT DEN DECKEL (ODER DIE RÜCKSEITE) ENTFERNEN. IM GERÄTEINNEREN BEFINDEN SICH KEINE VOM NUTZER REPARIERBARE TEILE. ÜBERLASSEN SIE REPARATUREN DEM QUALIFIZIERTEN KUNDENDIENST</p>	 <p>Ein Ausrufungszeichen in einem Dreieck weist den Nutzer auf wichtige Bedienungs- und Wartungsanweisungen in den Dokumenten hin, die dem Gerät beiliegen</p>
<p>1. Bitte lesen Sie diese Bedienungsanleitung aufmerksam durch. Sie sollten wirklich alle Hinweise zum Betrieb und zu Ihrer Sicherheit lesen, bevor Sie das Produkt in Betrieb nehmen.</p> <p>2. Alle Warnhinweise auf dem(n) Produkt(en) oder in der Bedienungsanleitung müssen unbedingt beachtet werden.</p> <p>3. Beachten Sie die Anleitung. Befolgen Sie bitte unbedingt alle Bedien- und Gebrauchshinweise.</p> <p>5. Benutzen Sie dieses Produkt nicht in der Nähe von Wasser.</p> <p>6. Verwenden Sie zur Reinigung keine flüssigen Reinigungsmittel oder solche aus der Sprühdose, sondern nur ein weiches Tuch.</p> <p>7. Schlitze und Öffnungen im Gehäuse dienen der Entlüftung und sorgen für zuverlässigen Betrieb. Daher dürfen sie nicht verstellt oder abgedeckt werden. Stellen Sie dieses Produkt so auf, wie vom Hersteller empfohlen.</p> <p>8. Stellen Sie das Produkt nicht in der Nähe von Wärmequellen auf (Heizstrahler, Heizkörper, Öfen usw.). Sollten Sie es in unmittelbarer Nähe eines Verstärkers aufstellen, klären Sie mit dem Hersteller, ob das zulässig ist.</p> <p>9. Netzleitungen sollte man immer so verlegen, dass niemand auf sie steigt und dass sie nicht durch irgendwelche Gegenstände eingeklemmt werden. Besonders vorsichtig sollte man mit Netzkabeln an Steckern und Mehrfachdosen umgehen und an der Stelle, wo das Kabel aus dem Gerät kommt (Knick-Gefahr!).</p> <p>10. Verwenden Sie ausschließlich Zubehör, das der Hersteller empfiehlt.</p> <p>11. Benutzen Sie ausschließlich fahrbare oder sonstige Untergestelle, dreibeinige Standfüße, Unterseztbügel oder Tische, die der Hersteller empfiehlt oder die mit den Lautsprechern gekauft wurden. Verwenden Sie ein fahrbares Untergestell, müssen Sie darauf achten, dass dieses samt Lautsprecher nicht umkippt und Verletzungen verursacht.</p>	<p>12. Sie sollten dieses Produkt während eines Gewitters oder einer längeren Zeitspanne, in der es nicht verwendet wird (z.B. während des Urlaub), vom Stromnetz trennen.</p> <p>13. Überlassen Sie bitte Reparaturen unbedingt qualifizierten Servicetechnikern. Bei den folgenden Beschädigungen trennen Sie bitte das Gerät vom Stromnetz und suchen Sie eine autorisierte Werkstatt auf: defektes Netzkabel oder Netzstecker, Ins Gehäuse sind Gegenstände oder Flüssigkeiten eingedrungen, das Gerät wurde Regen oder Wasser ausgesetzt, das Gerät arbeitet nicht einwandfrei oder fiel herunter.</p> <p>14. Verwenden Sie kein Zubehör, das vom Hersteller nicht ausdrücklich freigegeben wurde, sonst riskieren Sie einen Kurzschluss oder andere Schäden.</p> <p>15. Dieses Produkt darf nur mit derjenigen Netzspannung betrieben werden, die auf dem Hinweisschild angegeben ist. Sollten Sie nicht genau wissen, welche Netzspannung in Ihrem Haus vorhanden ist, fragen Sie Ihren Händler. Hinweise zur Handhabung von Produkte, die von Batterien, Akkus oder einer anderen Energiequelle gespeist werden finden Sie in der entsprechenden Bedienungsanleitung.</p> <p>16. Vermeiden Sie eine Überlastung von Steckdosen, Verlängerungskabeln oder Mehrfachdosen, weil das zu Brandgefahr und Stromschlagrisiko führen können.</p>	<p>17. Achten Sie darauf, dass niemals irgendwelche Fremdkörper durch die Öffnungen ins Geräteinnere fallen. Diese könnten mit Spannung führenden Teilen in Berührung kommen oder einen Kurzschluss auslösen. Dadurch entsteht möglicherweise die Gefahr eines Stromschlags oder dass ein Gerät in Brand gerät. Verschütten Sie auch niemals irgendwelche Flüssigkeiten über dem Gerät.</p> <p>18. Versuchen Sie niemals das Gerät selbst zu reparieren. Wenn Sie die Abdeckung abnehmen oder entfernen, können Sie sich gefährlichen Spannungen oder anderen Gefahrenquellen aussetzen. Überlassen Sie bitte Reparaturen unbedingt qualifizierten Servicetechnikern.</p> <p>19. Wurden Ersatzteile benötigt, vergewissern Sie sich, dass der Servicetechniker Originalteile des Herstellers verwendet hat oder dass die verwendeten Ersatzteile die gleichen technischen Werte besitzen wie die Originalteile. Der Einbau von ungeeigneten Ersatzteilen kann zu Brand, Stromschlaggefahr oder anderen Schäden führen.</p> <p>20. Bitten Sie nach allen Service- oder Reparaturarbeiten den Servicetechniker einen Sicherheitsingenieur einen Sicherheitstest durchzuführen, um zu gewährleisten, dass das Gerät in einem ordnungsgemäßen Betriebszustand befindet.</p> <p>21. Montieren Sie die Lautsprecher nur dann an einer Wand oder an der Decke, wenn es der Hersteller empfiehlt und folgen Sie dabei seinen Anweisungen.</p>

Léase primero.

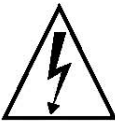
Importantes instrucciones de seguridad

 <p>El símbolo del relámpago con punta de flecha, dentro de un triángulo equilátero, alerta al usuario de la presencia de una «tensión peligrosa» sin aislar en el interior del producto, que puede ser de la suficiente magnitud como para constituir un riesgo de descarga eléctrica para las personas.</p>	<div style="border: 1px solid black; padding: 5px; text-align: center;"> CAUTION RISK OF ELECTRIC SHOCK DO NOT OPEN </div> <p>PRECAUCIÓN: Para reducir el riesgo de descarga eléctrica, no retire la tapa (ni la cubierta posterior). En el interior no hay piezas utilizables por el usuario. Cualquier reparación deberá ser realizada por personal técnico cualificado.</p>	 <p>El signo de exclamación dentro de un triángulo equilátero alerta al usuario de la existencia de importantes instrucciones sobre funcionamiento y mantenimiento (asistencia) en la documentación que acompaña al equipo.</p>
<ol style="list-style-type: none"> 1. Lea las instrucciones. 2. Guarde las instrucciones. 3. Observe todas las advertencias. 4. Siga todas las instrucciones. 5. No utilice este equipo cerca del agua. 6. Limpie el equipo únicamente con un paño seco. 7. No bloquee las aberturas de ventilación. Realice la instalación de acuerdo con las instrucciones del fabricante. 8. No instale el equipo cerca de ninguna fuente de calor, tales como radiadores, estufas u otros aparatos que generen calor, incluidos los amplificadores. 9. No anule la función de seguridad del conector polarizado o con toma de tierra. El conector polarizado tiene dos patillas, una más ancha que la otra. El conector con toma de tierra tiene dos patillas y una tercera de conexión a tierra. La lámina ancha o tercera patilla son una medida de seguridad. Si no encaja en la base, consulte a un electricista la sustitución de la toma obsoleta. 10. El cable de alimentación debe protegerse para que no resulte aplastado o pellizcado, especialmente en los conectores, bases múltiples y punto de salida del equipo. 11. Utilice exclusivamente los accesorios indicados por el fabricante. 12. Instale el producto únicamente en el carro, estante, trípode, soporte o mueble que recomiende el fabricante o acompañe al producto. Si utiliza un soporte con ruedas, exteme las precauciones cuando traslade el conjunto para evitar daños en caso de vuelco. 13. Desconecte el equipo durante las tormentas eléctricas y cuando no se vaya a utilizar durante un periodo prolongado. 	<ol style="list-style-type: none"> 14. Las tareas de servicio técnico deberán ser realizadas por personal cualificado. Dicha asistencia será precisa cuando la unidad haya resultado dañada de alguna forma, como por ejemplo: cable o conector de alimentación dañados, entrada de líquido o cuerpo extraño en la unidad, exposición a la lluvia o humedad, funcionamiento anómalo o caída del equipo. 15. Para evitar posibles riesgos, no utilice accesorios que no hayan sido recomendados por el fabricante. 16. Este producto deberá alimentarse únicamente con el suministro indicado en el etiquetado. Si no está seguro del tipo de suministro de su hogar, consulte al distribuidor del equipo o a su compañía eléctrica. En el caso de los productos concebidos para funcionar con pilas u otras fuentes de alimentación, consulte las instrucciones de uso. 17. Si se conecta una antena exterior o sistema de cable al equipo, compruebe que disponen de puesta a tierra como protección contra subidas de tensión y cargas estáticas acumuladas. El Artículo 810 del National Electrical Code, ANSI/NFPA 70, ofrece información sobre la correcta conexión a tierra del poste y la estructura de soporte, la conexión a tierra del cable de entrada a una unidad de descarga de antena, el tamaño de los conductores de tierra, la situación de la unidad de descarga de antena, la conexión a los electrodos de toma de tierra, y los requisitos del electrodo de toma de tierra. 18. Un sistema de antena exterior no deberá instalarse en la proximidad de tendidos eléctricos aéreos ni de otros circuitos de iluminación o corriente, ni en lugares en los que pueda interferir con dichas líneas de tensión o circuitos. Cuando instale un sistema de antena exterior, exteme las precauciones para evitar el contacto con las líneas o circuitos eléctricos, ya que podría tener consecuencias fatales. 	<ol style="list-style-type: none"> 19. No sobrecargue las tomas murales, cables alargadores o bases múltiples, y así evitará posibles riesgos de incendio o descarga eléctrica. 20. No introduzca objetos de ninguna clase en el equipo a través de sus aberturas, ya que podrían hacer contacto con puntos de tensión peligrosos o cortocircuitar piezas, con el consiguiente riesgo de incendio o descarga eléctrica. No permita que se derrame ninguna clase de líquido sobre el equipo. 21. No intente realizar tareas de asistencia técnica por su cuenta, toda vez que la apertura o retirada de las cubiertas podrá entrañar riesgos de exposición a tensiones peligrosas o de otra naturaleza. Cualquier tarea de servicio técnico deberá ser realizada por personal cualificado. 22. En caso de que se necesiten piezas de repuesto, asegúrese de que el técnico de servicio utiliza recambios especificados por el fabricante o de las mismas características que la pieza original. Los recambios sin autorización pueden ocasionar riesgos de incendio o descarga eléctrica, entre otros. 23. Tras completar cualquier tarea de servicio o reparación en este producto, solicite al técnico que efectúe las comprobaciones de seguridad necesarias para determinar que el producto se encuentra en perfecto estado de funcionamiento. 24. El producto se montará en pared o techo únicamente siguiendo las recomendaciones del fabricante.

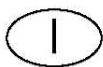

6





Leggere Prima dell'Uso! Importanti Precauzioni di Sicurezza!

 <p>Il lampo con estremità a freccia contenuto in un triangolo equilatero rappresenta un allerta per l'utilizzatore, a significare la presenza di "corrente pericolosa" non isolata all'interno del cabinet del prodotto, corrente che potrebbe essere di magnitudine sufficiente a costituire un elemento di rischio di shock elettrico per le persone.</p>	 <p>ATTENZIONE: Onde ridurre il rischio di shock elettrici, mai rimuovere il coperchio (o i fondelli) dell'apparecchio. Non ci sono parti riparabili dall'utilizzatore all'interno. personnel.</p>	 <p>Il punto esclamativo all'interno di un triangolo equilatero rappresenta un allerta per l'utilizzatore, a significare la presenza di importanti istruzioni operative e di manutenzione (assistenza) nella letteratura che accompagna l'apparecchiatura.</p>
<p>1. Leggete queste istruzioni. 2. Conservate il Manuale. 3. Osservate tutte le Precauzioni. 4. Seguite tutte le Istruzioni. 5. Non impiegate questo apparato in prossimità di acqua. 6. Pulitelo solo con un panno asciutto. 7. Non ostruite alcuna fessurazione di raffreddamento. Installate l'apparecchio in osservanza delle istruzioni fornite dal costruttore. 8. Non installare l'apparecchio in prossimità di fonti di calore, quali termosifoni, stufe o altri apparati (inclusi gli amplificatori) che producono calore. 9. Non mancate di osservare le precauzioni di sicurezza rappresentate dagli elementi delle spine polarizzate o del tipo con messa a terra. Una spina polarizzata è costituita da due lamelle di cui una più grande dell'altra, una spina con messa a terra è costituita da due lamelle o da due connettori tubolari. La lamella più grande o il terzo connettore sono impiegati per la vostra sicurezza. Se la spina fornita non si adatta alla vostra presa, consultate un elettricista affinché tale presa, obsoleta, venga sostituita. da un terzo connettore di terra, una spina con messa a terra Impiegate solo staffe o accessori consigliati dal costruttore. 10. Proteggete i cordoni di rete in maniera tale che non vengano calpestati, interrotti o bucati da oggetti posti su di essi, con particolare attenzione ai punti di inserimento nelle prese elettriche e nel telaio dell'apparecchio. 11. Usate solo staffe/accessori specificati dal costruttore. 12. Impiegate solo quei carrelli, piedistalli, treppiedi, staffe o tavoli raccomandati dal costruttore o venduti assieme al prodotto. Quando usate un carrello per il trasporto, spostate con cautela l'insieme carrello/apparecchio così da evitare possibili danni alla persona derivanti da ribaltamento. Periodi di Non Impiego 13. Scollegate l'apparecchio dalla rete in caso di temporali, tempeste magnetiche, o quando si ipotizza di non impiegare l'apparecchio per lunghi periodi di tempo.</p>	<p>14. Fate effettuare eventuali interventi di assistenza solo da personale autorizzato e qualificato. L'assistenza va richiesta ogni volta che l'apparecchio presenta un danno di qualsiasi genere: cordone di rete o spina danneggiati, nel caso che liquidi o piccoli oggetti siano penetrati all'interno dell'apparecchio, ove l'apparecchio sia stato esposto all'umidità o alla pioggia, risulti non funzionare propriamente o sia caduto. 15. Non impiegate staffe o altri similari accessori che non siano stati espressamente consigliati dal costruttore. Potrebbero rivelarsi pericolosi. Calore. Il prodotto dovrebbe essere posizionato lontano da sorgenti di calore, come caloriferi, pompe di calore, essiccatori o altri prodotti (inclusi gli amplificatori) che producano calore. 16. Questo prodotto dovrebbe essere impiegato solo con alimentazione a 230V, come indicato sull'apposita etichetta. Se non siete sicuri del valore di corrente di alimentazione nella vostra zona, consultate il vostro rivenditore o l'ente fornitore di energia. Per prodotti il cui funzionamento è previsto a batteria, fate riferimento alle istruzioni operative. 17. Se all'apparecchio viene collegato ad un'antenna esterna o ad un sistema di ricezione via cavo, assicuratevi che l'antenna o il sistema via cavo siano correttamente messi a terra, così da fornire possibile protezione contro i picchi di corrente e le cariche statiche. L'Articolo 810 del National Electrical Code, contiene informazioni riguardanti la corretta messa a terra dell'impianto di antenna e delle sue strutture di supporto, la messa a terra del cavo interno ad un'unità di scarico dell'antenna, le dimensioni dei connettori di terra, il posizionamento dell'unità di scarico dell'antenna, il collegamento agli elettrodi di messa a terra, e le specifiche per l'elettrodo di messa a terra.</p>	<p>18. Un sistema d'antenna esterno non dovrebbe mai essere posizionato nelle vicinanze di linee ad alta tensione o di impianti d'illuminazione o altre circuitazioni di potenza, né in luoghi ove nell'eventualità di caduta del sistema, esso possa finire sulle già menzionate installazioni. Quando si monta un sistema di antenna esterna, va usata estrema cautela nel non rischiare mai di toccare tali installazioni, dal momento che il contatto con esse può risultare fatale. 19. Mai sovraccaricare le prese di rete, le prolunghe o i ricetraccoli dei cordoni, dal momento che ciò può comportare rischi d'incendio o di shock elettrico. 20. Mai inserire oggetti di alcun tipo nelle fessure del mobile dell'apparecchio, dal momento che potrebbero entrare in contatto con punti di corrente pericolosi o creare corto-circuiti che possono essere causa d'incendio o di shock elettrico. Mai far entrare liquidi nell'apparecchio. 21. Mai tentare di riparare l'apparecchio per proprio conto, dal momento che l'apertura o la rimozione delle coperture può esporvi a scariche di corrente ed altri rischi. Rivolgetevi a personale qualificato. 22. Ove occorrono parti di ricambio, assicuratevi che il servizio tecnico impieghi quelle parti specificate dal costruttore o che abbiano le medesime caratteristiche delle parti originali. Sostituzioni arbitrarie possono essere causa di incendio, shock elettrico o altri danni. 23. Dopo l'effettuazione di qualsiasi intervento di assistenza o di riparazione, domandate al tecnico di effettuare una verifica di sicurezza, onde determinare che l'apparecchio sia nelle corrette condizioni operative. 24. Il prodotto dovrebbe essere montato a parete o a soffitto solo se espressamente raccomandato dal costruttore.</p>

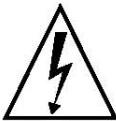

Leia Primeiro!

Importante Precauções de Segurança

 <p>O símbolo de um relâmpago com uma ponta de seta, dentro de um triângulo equilátero, tem a intenção de alertar o utilizador para a presença de “tensão perigosa” não isolada dentro da caixa do produto, que pode ser de uma magnitude suficiente para continuar um risco de choque eléctrico às pessoas.</p>	<div style="border: 1px solid black; padding: 5px; text-align: center;"> <p>CAUTION RISK OF ELECTRIC SHOCK DO NOT OPEN</p> </div> <p>Cuidado: Para reduzir o risco de choque eléctrico não retire a tampa (ou o painel posterior). Não há peças reparáveis no interior. Mande reparar por pessoal qualificado.</p>	 <p>O ponto de exclamação dentro de um triângulo equilátero tem a intenção de alertar o utilizador para a presença de instruções importantes de operação e manutenção na literatura que acompanha o aparelho.</p>
<ol style="list-style-type: none"> 1. Leia estas instruções. 2. Guarde estas instruções. 3. Respeite todos os avisos. 4. Siga todas as instruções. 5. Não utilize este aparelho perto de água. 6. Limpe apenas com um pano seco. 7. Não tape nenhuma abertura de ventilação. Instale de acordo com as instruções de fabrico. 8. Não instale perto de fontes de calor, como fogões ou outra qualquer fonte que irradie calor. 9. Não estrague a finalidade de segurança da ficha de polarização ou da ficha tipo terra. A ficha de polarização têm duas lâminas cada uma diferente uma da outra. A ficha de terra têm duas lâminas e uma terceira ligação á terra. Esta ficha só encaixa na tomada num sentido. Se a ficha não encaixar, contacte um electricista para substituir a sua tomada obsoleta. 10. Os cabos de alimentação devem ser colocados de forma a não serem passíveis de serem pisados ou esmagados por objectos, com particular atenção aos pontos junto a tomadas, tomadas de corrente e ao ponto de saída do produto. 11. Utilize unicamente acessórios específicos do fabricante. 12. Use somente com o carro, o carrinho, o tripé, o suporte ou a tabela especificada pelo fabricante. Quando um carro é usado, cuidado ao mover a combinação do instrumento do carro para evitar sobre ferimento da ponta. 13. Desligue o aparelho da tomada durante trovoadas ou longos períodos em que o aparelho não esteja em utilização. 	<ol style="list-style-type: none"> 14. Consulte tudo que presta serviços de manutenção ao pessoal de serviço qualificado. Prestar serviços de manutenção é requerido quando o instrumento estiver danificado, tais como o cabo da fonte de alimentação ou a tomada é danificada, líquido for derramado ou objectos caírem no aparelho, o aparelho for exposto à chuva ou à humidade, não funciona normalmente, ou ter caído no chão. 15. Não utilize acessórios não recomendados pelo fabricante, podem causar avarias. 16. Este produto deve ser utilizado apenas com o tipo de fonte de alimentação indicado na etiqueta da marca. Se não está certo do tipo de aprovisionamento eléctrico da sua casa, consulte o seu revendedor ou companhia de electricidade local. Para produtos concebidos para funcionar a pilhas ou outro tipo de alimentação, consulte o manual de instruções. 17. Se uma antena ou cabo exterior estiver ligado ao produto, tenha a certeza que o sistema de antena ou o cabo têm terra ligado para protecção de tensão e de cargas estáticas. Artigo 810 do Código Nacional de Electricidade ANSI/NFPA 70, fornece a informação no que diz respeito a terra apropriado da ligação - no fio a uma unidade da descarga da antena, à conexão a terra os eléctrodos, e às exigências para o eléctrodo terra. 18. Um sistema exterior de antena não deve ficar situado na vizinhança de linhas de potência aéreas ou de outros circuitos de luz eléctrica ou de potência, ou onde pode cair em tais linhas ou circuitos de potência. Ao instalar um sistema exterior da antena, cuidado extremo deve ser tomado não tocar nas linhas de potência ou circuitos, o contacto com elas poder seja fatal. 	<ol style="list-style-type: none"> 19. Não sobrecarregue tomadas de parede, cabos da extensão, ou receptáculos integrais de conveniência, com isto pode resultar em risco de fogo ou de choque eléctrico. 20. Nunca introduza objectos neste produto, podem tocar em pontos ou em tensão perigosa podendo assim resultar em fogo ou em choque eléctrico. Nunca derrame líquido em cima do produto. 21. Não tente prestar serviços de manutenção a este produto você mesmo, como abrir ou remover as tampas perigo tensão perigosa ou outros perigos. Consulte tudo que presta serviços de manutenção ao pessoal de serviço qualificado. 22. Quando as peças de substituição são requeridas, tenha a certeza que o técnico usou as peças de substituição recomendadas pelo fabricante ou as mesmas tem características iguais ás originais. Substituições não autorizadas podem resultar em fogo, choques eléctricos ou outros perigos. 23. Quando o produto estiver reparado, peça ao técnico de serviço que execute verificações de segurança para determinar se o produto está em condições de funcionar sem qualquer problema. 24. O produto pode ser instalado na parede ou num tecto seguindo as instruções do fabricante.

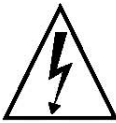

Lue tämä ensin!

Tärkeitä turvallisuusohjeita!

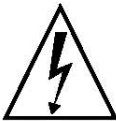

 <p>Kolmion sisällä oleva salamatunnus varoittaa käyttäjää kotelon sisäistä eristämättömistä jännitteistä. Jännitteet saattavat olla niin voimakkaita, että ne aiheuttavat vakavan sähköiskun vaaran.</p>	<div style="border: 1px solid black; padding: 5px; text-align: center;"> CAUTION RISK OF ELECTRIC SHOCK DO NOT OPEN </div> <p>VAROITUS: Vältä sähköiskun vaara älä avaa laitteen koteloa. Laitteen sisällä ei ole käyttäjän huollettavia osia. Anna valtuutetun huoltoliikkeen suorittaa kaikki huoltotyöt.</p>	 <p>Kolmion sisällä oleva huutomerkki ilmoittaa, että käyttöohjeissa on erityisen tärkeitä kyseessä olevaan kohteeseen liittyviä käyttö- tai huolto-ohjeita.</p>
<ol style="list-style-type: none"> 1. Tutustu käyttöohjeeseen. 2. Säilytä käyttöohje. 3. Huomioi varoitukset. 4. Noudata käyttöohjeita. 5. Älä käytä tätä laitetta veden läheisyydessä. 6. Käytä puhdistukseen vain kuivaa liinaa. 7. Älä tuki laitteen ilmastointiaukkoja. Sijoita laite käyttöpaikkaansa valmistajan ohjeiden mukaisesti. 8. Älä sijoita laitetta lämmönlähteiden läheisyyteen. Sellaisia ovat esimerkiksi lämmittimet, lämminilmaritilät, takat ja lämpöä tuottavat elektroniset laitteet, esimerkiksi vahvistimet. 9. Muista maadoituksen merkitys. Joissakin laitteissa on maadoitettu virtajohto. Maadoitetun pistokkeen tunnet siitä, että siinä on kahden kontaktipiikin lisäksi kaksi vastakkaisilla puolilla olevaa metalliliuskaa. Jos laitteesi sähköpistoke ei sovi seinäkoskettimeen, ota yhteyttä myyjäliikkeeseen tai sähköasentajaan. 10. Varmista, ettei virtajohto ole alttiina ulkoisille, esimerkiksi ihmisten tai eläinten kulkemisen aiheuttamille vaurioille, ja että johto ei jää kalusteiden alle puristukseen. Erityisen arkoja kohtia ovat pistokkeet ja virtajohdon läpimeno laitteen koteloon. 11. Käytä vain valmistajan hyväksymiä tarvikkeita ja lisälaitteita. 12. Käytä laitteen sijoituksessa vain laitteen valmistajan hyväksymiä, valmistamia tai myymiä telineitä, hyllyjä, pöytiä, kiinnikkeitä ja pidikkeitä. Jos sijoitat laitteen pyörillä varustetulle laitehyllylle, varo liikkuttamisen aikana laitteen pudottamista. 13. Irrota laite sähköverkosta ukkosen ajaksi tai jos poistut kotoa pidemmäksi ajaksi. Kytke laite irti myös antenni- tai kaapeliverkosta. 	<ol style="list-style-type: none"> 14. Jos laite kaipaa huoltoa, toimita se valtuutettuun huoltoliikkeeseen. Huolto on tarpeen, jos laite on jollakin tavalla vaurioitunut (esimerkiksi sen virtajohto tai pistotulppa on rikkoutunut), laitteen sisään on päässyt vieras esine tai nestettä, laite on kastunut, laite ei toimi normaalisti, vaikka noudatat kaikkia käyttöohjeita, tai jos laite on pudonnut. 15. Älä käytä muita kuin valmistajan suosittelemia lisätarvikkeita. Muut lisätarvikkeet saattavat aiheuttaa vaaratilanteen. 16. Laitteen saa kytkeä vain tyyppikilvessä mainittuun virtalähteeseen. Ellet ole varma kotisi verkkojännitteestä, kysy ohjeita jälleenmyyjältäsi tai sähkötoimittajaltasi. Paristo- tai akkukäyttöisten laitteiden yhteydessä toimintaohjeet löytyvät käyttöohjeesta. 17. Jos kytket laitteen ulkoantenniin tai kaapeliverkkoon varmista, että järjestelmä on maadoitettu jännitepiikkien ja staattisen sähkön varalle. Saat lisätietoa antenniasennuksista esimerkiksi viranomaisen ja jakeluoperaattoreiden kirjallisista ohjeista (esimerkkinä luku 810 oppaassa National Electrical Code, ANSI/NFPA 70). Niissä kerrotaan, miten antennimasto pitää maadoittaa, tarvittavien johtimien ja tarvikkeiden mitoituksista ja muista asiaan vaikuttavista seikoista. 18. Älä asenna ulkoantennia ylikulkevien sähkölinjojen tai muiden virtajohtojen läheisyyteen tai paikkaan, missä antenni saattaa pudotessaan koskettaa virtajohtoa. Varo myös koskettamasta virtajohtoja asentaessasi antennia, koska kosketus voi olla tappava. 	<ol style="list-style-type: none"> 19. Varmista, ettei ylikuormita takalevyn pistorasioita, jatkojohtoja tai seinäpistorasioita eli älä kytke niihin liian suurta virtaa kuluttavia laitteita. Ylikuormitus saattaa aiheuttaa tulipalon tai sähköiskun vaaran. 20. Älä koskaan työnnä mitään esineitä laitteen aukkoihin. Ne saattavat osua jännitteellisiin osiin tai aiheuttaa oikosulun, mikä voi puolestaan aiheuttaa tulipalon tai sähköiskun vaaran. Älä koskaan läikytä mitään nestettä laitteen päälle. 21. Älä yritä huoltaa laitetta itse, koska kotelon avaaminen altistaa sinut sähköiskun vaaraan. Jätä kaikenlainen huoltaminen valtuutetuille ammattilaisille. 22. Jos laite kaipaa huoltoa varmista, että asentaja käyttää vain alkuperäisvaraosia tai varaosia, joilla on samat ominaisuudet kuin alkuperäisvaraosilla. Väärien osien käyttö saattaa aiheuttaa tulipalon, sähköiskun tai muun vaaratilanteen. 23. Pyydä asentajaa suorittamaan tarvittavat turvallisuus tarkastukset kaikkien korjaus- ja huoltotoimenpiteiden jälkeen. 24. Sijoita tuote seinälle tai kattoon vain siinä tapauksessa, että sellainen sijoitusvaihtoehto on mukana laitteen valmistajan sijoitusohjeissa.

Läs detta först!

Viktig säkerhets information.

 <p>Symbolen med en blix, innebär att produkten innehåller strömförande ledningar som kan ge elstötar.</p>	<div style="border: 1px solid black; padding: 5px; text-align: center;"> CAUTION RISK OF ELECTRIC SHOCK DO NOT OPEN </div> <p>Varning: För att förhindra elstötar skall du ej ta av skyddshuven. Vid service, lämna alltid produkten till godkänd servicepersonal.</p>	 <p>Symbolen med utropsteknet, vill påvisa att den finns viktig information om produkten i den literatur som följer med apparaten.</p>
<ol style="list-style-type: none"> 1. Läs instruktionen. 2. Spara denna instruktion 3. Följ alla varningstexter. 4. Följ alla instruktioner 5. Placera inte produkten så att den kan bli blöt. 6. Rengör endast med en torr duk. 7. Blockera inte ventilationshålen. Installera produkten enligt manualen. 8. Placera inte produkten nära värmekällor, så som element, spis eller annan apparatur som allstrar värme. 9. Använd jordad kontakt om det finns sådan. Om den medlevererade nätkontakten inte stämmer med vägguttaget, bör du konsultera en elektriker för eventuellt byte av kontakt. 10. Se till så att nätsladden inte skaddas. 11. Använd endast de tillbehör som specificeras i manualen. 12. Om du använder en transportkärra för att flytta produkten se till så att transporten kan ske utan att kartongen kan tippa. 13. Ta ut nätsladden från vägguttaget vid åska eller när du inte använder produkten under en längre tid. 	<ol style="list-style-type: none"> 14. Behöver din produkt service, vänd dig alltid till en auktoriserad serviceverkstad. Service kan behövas när produkten inte fungerar som den skall, men även när du kan ha spillt vatten, föremål har kommit in i apparaten eller att den har blivit utsatt för regn. 15. Om inte tillverkaren har angivit något, bör du inte fästa något på produkten. 16. Denna produkt skall enbart drivas med den nätspänning som angivet på baksidan. Om du inte är klar över viken nätspänning du har i ditt hus, bör du kontrollera med husvärden eller elbolaget. Om det är en produkt som skall drivas med batteri eller en annan typ av nätdapter, skall du konsultera bruksanvisningen. 17. Om du använder en utomhusantenn, är det viktigt att antennen är monterad enligt alla regler när det gäller jordning. Prata med din installatör hur installationen är gjord. 18. En utomhus antenn skall inte monteras så att den kommer i närheten av en strömförande ledning. Skulle antennen blåsa ned och hamna på en strömförande ledning kan detta orsaka skada på din produkt. 	<ol style="list-style-type: none"> 19. Överbelasta inte vägguttagen, skarvdosor eller liknande nätanslutningar, eftersom detta kan innebära brandfara eller att du kan få elstötar. 20. Peta aldrig med någonting igenom ventilationshållen på apparaten, detta kan orsaka kontslutning och som följd av detta kan eld uppstå. Använd inte heller någon vätska i närheten av apparaten. 21. Försök inte att reparera produkten själv, lämna den alltid till en godkänd serviceverkstad. 22. När komponenter skall bytas ut i apparaten, se till så att serviceverkstaden alltid använder av tillverkaren godkända komponenter. 23. Efter en service är det viktigt att servicepersonalen gör en säkerhetskontroll innan apparaten lämnas ut. 24. Om produkten skall monteras på väggen skall det alltid göras enligt tillverkaren rekommendationer.

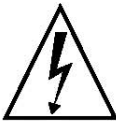
Vigtige Sikkerhedsinformationer!

 <p>Lynsymbolet i trekant advarer brugeren om uisolere farlig spænding inde i apparatet, som kan udgøre stødfare for mennesker.</p>	<div style="border: 1px solid black; padding: 5px; text-align: center;"> CAUTION RISK OF ELECTRIC SHOCK DO NOT OPEN </div> <p>ADVARSEL: For at minimere risiko for elektrisk stød, bør svøb eller bagside aldrig fjernes. Der er ingen indvendige brugerbetjente dele. Al service henvises til autoriseret værksted.</p>	 <p>Udråbstegn i trekant skal gøre brugeren opmærksom på at der i den medfølgende literatur findes vigtige instruktioner vedr. betjening og service af produktet.</p>
<ol style="list-style-type: none"> 1. Læs instruktionerne grundigt. 2. Opbevar instruktionerne sikkert. 3. Overhold alle advarsler. 4. Følg alle instruktioner nøje. 5. Produktet må ikke benyttes tæt på vand. 6. Brug kun en tør klud til rengøring. 7. Ventilationsåbninger må ikke blokeres eller tildækkes. Produktet installeres i henhold til producentens anvisninger. 8. Produktet skal placeres væk fra varmekilder som radiator, direkte sollys, ovn/komfur eller andre apparater (også effektforstærkere) der udstråler varme. 9. Lysnetledninger skal placeres så de ikke klemmes af gående eller af genstande placeret på eller ved dem. Pas især godt på ved stik, stikdåse og dér hvor ledningen kommer ud af produktet. 10. Tilsluttes/monteres kun tilbehør/ekstraudstyr specificeret af producenten. 11. Brug kun underlag, stand, trefod, beslag eller bord anbefalet af producenten eller som sælges sammen med produktet. Produktet på en flytbar vogn bør flyttes med forsigtighed for at undgå skader. 12. Træk stikket ud i tordenvejr eller når produktet ikke skal bruges i længere tid. 13. Al service henvises til autoriseret værksted. Service kræves f.eks. ved skade på lysnetledning eller -stik, hvis væske eller fremmede genstande er trængt ind i produktet, hvis produktet har været udsat for regn eller anden fugt, hvis produktet ikke fungerer korrekt ved normal betjening eller hvis produktet har været udsat for slag eller fald. 	<ol style="list-style-type: none"> 14. Brug aldrig tilbehør, m.m., som ikke er anbefalet af producenten, da det kan udgøre fare. 15. Produktet må kun strømfødes med lysnetspænding som beskrevet bag på produktet. Hvis du ikke er bekendt med boligens strømforhold, kontakt din forhandler eller din el-leverandør. Hvis produktet benytter batteri eller anden strømkilde, se brugsvejledningen. 16. Hvis udendørsantenne eller kabelanlæg er tilsluttet produktet, skal antenne eller kabelanlæg have jordforbindelse som yder nogen beskyttelse mod pludselig strømstigning eller statiske opladninger. Søg kvalificeret rådgivning vedr. jordforbindelse af antennemast og støtteunderlag, forbindelse til aflader, tværsnit af stelledning, placering af aflader, forbindelse til jord samt øvrige krav til jordforbindelse. 17. En udendørsantenne bør ikke monteres tæt ved el-ledning el-mast eller andet strømførende, hvor der er risiko for berøring mellem dem. Ved opsætning af udendørs-antenne, skal der udvises stor forsigtighed for at undgå berøring med strømledninger. Sådan berøring kan være livsfarlig. 18. Stikkontakt, forlængerledning eller strømudtag bagpå apparater må aldrig overbelastes. Det kan give risiko for brand eller stød. 	<ol style="list-style-type: none"> 19. Fremmede genstande må aldrig presses gennem åbninger i apparatet. Det kan forårsage kortslutning med risiko for brand eller elektrisk stød. Af samme grund, bør man holde enhver form for væske langt væk fra produktet. 20. Forsøg aldrig selv at åbne eller reparere produktet. Det giver risiko for stød eller anden skade. Al service henvises til autoriseret værksted. 21. Serviceteknikeren må kun benytte reservedele specificeret af producenten eller med egenskaber identiske til originaldelen. Uautoriserede dele kan forårsage brand, stød eller anden skade. 22. Efter endt service, bør serviceteknikeren gennemføre sikkerheds-check for at sikre at produktet fungerer normalt. 23. Montering i loft eller på væg må kun ske i henhold til producentens anvisninger.

Thank you for buying an iCub. iCub employs a new "all-in-one concept" being a high-powered 2.1 system with subwoofer. It was designed to answer the needs of new users, employing new technologies and multimedia, without requiring an additional amplifier but providing true hi-fi performance. Combined with the loudspeakers from the Sib & Co line, iCub integrates easily and with a very high quality result. In order to benefit fully from iCub's performance and quality, we recommend that you carefully read this instruction manual. Please keep this manual in a safe place in case of need of future reference.

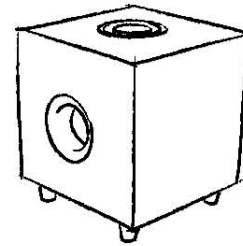

Specifications

All-in-one design with three BASH® amplifiers	for flexibility and ease of application.
One digital BASH® amplifier 150 Wrms / 200 Watts max.	high current output technology amplifier.
Two integrated digital BASH® amplifiers 2x75 Wrms / 100 Watts max.	to directly connect loudspeakers to iCub without an external stereo amplifier.
Subwoofer 8" (21 cm).	high performance Focal driver.
Preprogrammed active crossover with two positions	simplified connection with models Sib, Sib XL, or Sib XXL.
Autopower	standby, auto-on and delayed off for BASH® amplifiers.
Soft-clipping protection	avoids saturation of amplifiers and speakers.
Analog stereo on RCA jacks inputs	direct connection of traditional two channel sources.
Analog stereo inputs on mini-jack 3.5mm connector	direct connection of portable devices.
Digital optical input (Toslink)	direct connection of digital audio source, computer, or Wi-Fi station.
Integrated DA converters	translate digital audio in iCub.
Remote Control	wireless remote control of volume and motorized potentiometer.
Phase Inverter	optimizes coupling between iCub and speakers.
MDF construction	rigid, resonance free cabinet.
Streamlined port	powerful and distortion-free bass.

Loudspeaker connection

iCub is equipped with three BASH® technology amplifiers, one being a 150 Watts module for the subwoofer and two modules at 75 Watts each to power a pair of external loudspeakers.

Be careful to follow the phase of the loudspeaker cables in connecting the same lead from red connector indicated as "+" on the iCub to the red connector "+" on the corresponding loudspeaker.

Do the same for the black connectors indicated as "-",

Connection of Sib and Sib XL

Connect a pair of Sib XL or Sib directly from the powered amplifier connectors (*fig. A*) while respecting polarity.

Set the "High pass" switch to the Sib / Sib XL position as indicated. This position corresponds to a cutoff frequency between the iCub and the speakers at 110Hz.

Connection of Sib XXL

Connect the compact tower Sib XXL directly from the powered amplifier connectors (*fig. B*) while respecting polarity. Set the "High pass" switch to the Sib XXL position as indicated. This corresponds to a cutoff frequency between the iCub and the speakers at 85Hz.

Connection of other loudspeakers to iCub

It is possible to connect iCub to other loudspeakers than those in the Sib & Co family. If the speaker is small, set the "High pass" switch to Sib / Sib XL. If the speaker is larger or has superior performance and power handling in its bass response, set the switch to Sib XXL.

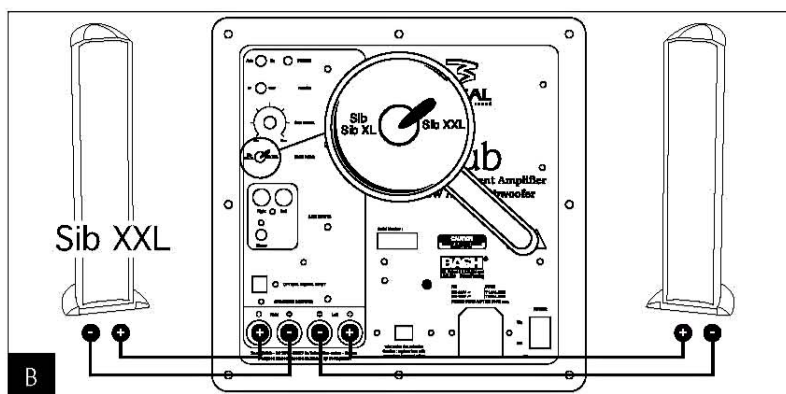
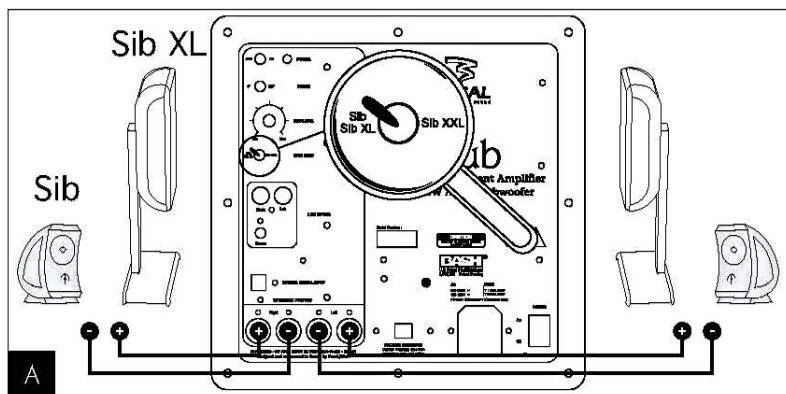

Connection of an audio source

iCub is designed to be ready to receive whichever audio source by either analog stereo connection or digital-optical connection (fig. C).

It is possible to connect a Mac computer or PC by digital cable or analog mini jack 3.5mm (depending on the sound card's specifications).

iCub offers an ideal solution for connection of portable devices, such as MP3 players or portable hard drive devices such as the iPod.

Note: It is possible to connect at the same time an analog source and a digital one on the iCub in their respective connectors. Only engage one device at a time or you will hear both signals at the same time. (there is however no danger to audio sources or the iCub)

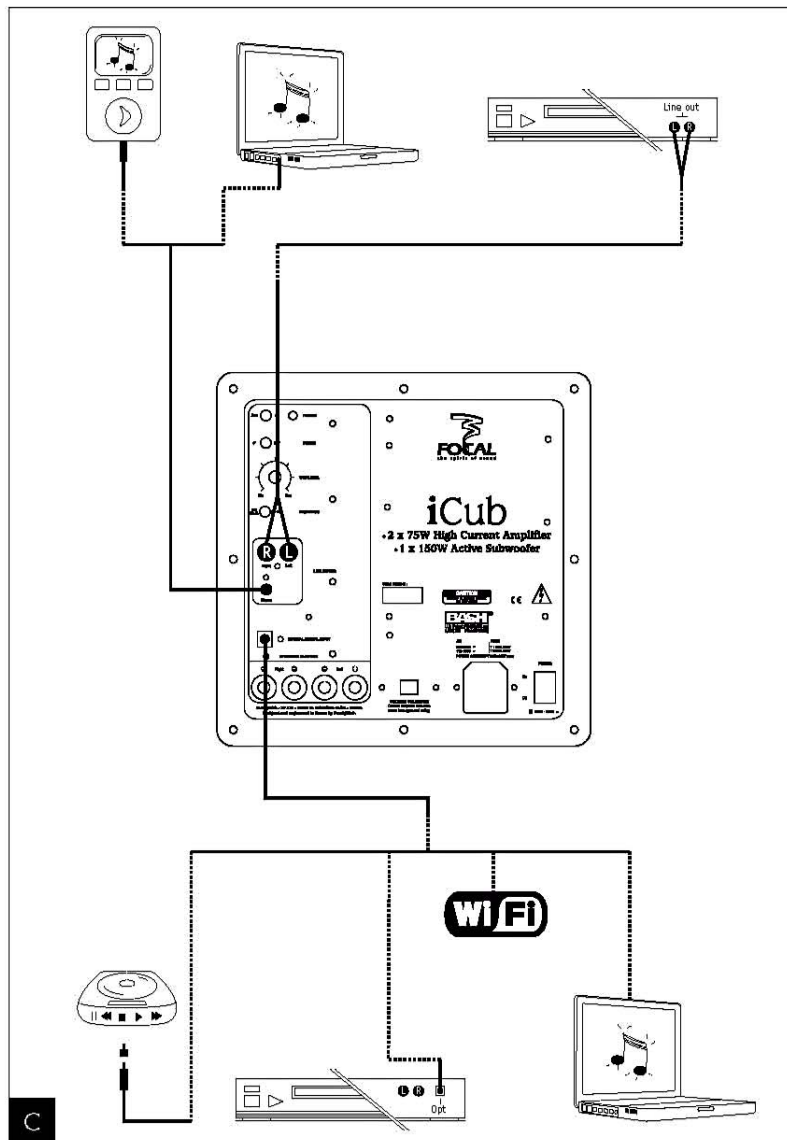

Analog connection

Using an appropriate cable, connect the outputs on the audio source to the RCA inputs or 3.5mm mini-jack on the iCub.

A quality cable offering adequate shielding is recommended, especially if a long cable is required between the source and the iCub (*Fig. D*).

Digital optical connection

This connection is recommended when possible to digital devices, such as CD, DVD, computers, digital portable devices, etc. Such a connection avoids all possible electronic or electromagnetic distortion for the cleanest, most dynamic listening without degradation (*fig. E*).

Note: direct connection to a DVD player requires an appropriate system setting determined by the DVD player. See your player's manual.

*Note: In portable digital players, the digital output is frequently the 3.5mm mini-jack standard. To connect this device to iCub, use an adapted cable 3.5mm mini-jack / Toslink or an optical adaptor (*fig. F*).*

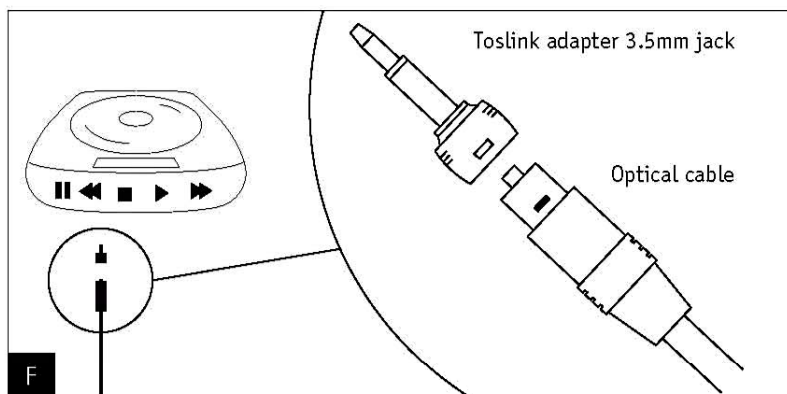
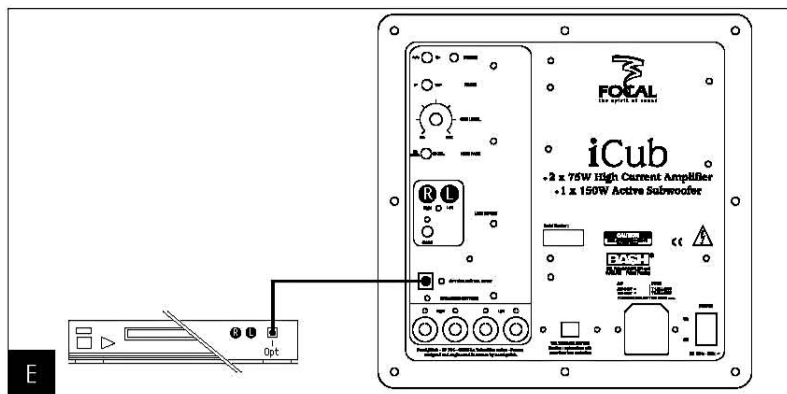
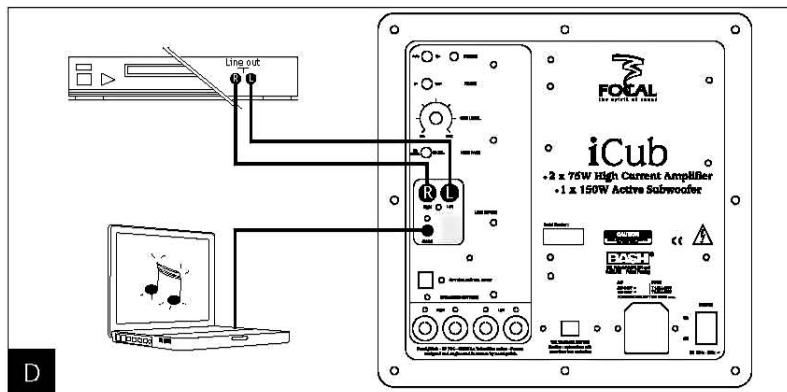

Connection of iCub to a Wi-Fi receiver

The iCub subwoofer can be directly connected to a wireless network thanks to a Wi-Fi station with audio capabilities. Such an installation permits a Wi-Fi equipped computer to act as an audio server and transmit the audio files wirelessly to the iCub.

Connection of iCub to an Apple® Airport Express™

The iCub works optimally with the Airport Express™ station by Apple®. This 802.11g (54 Mbps) Wi-Fi station is capable of transmitting compressed audio, but also native, non-compressed audio. It also allows the possibility of transmitting the original audio signal from CD with no alteration directly to iCub, creating a wireless audio system of very high quality (fig. G). Connection can be done with a traditional audio cable, but use of an optical digital cable is highly recommended for better definition and improved dynamics.

Note: Use of the station Airport Express™ requires the program iTunes™ from Apple Computer Inc®, compatible Macintosh® and PC.

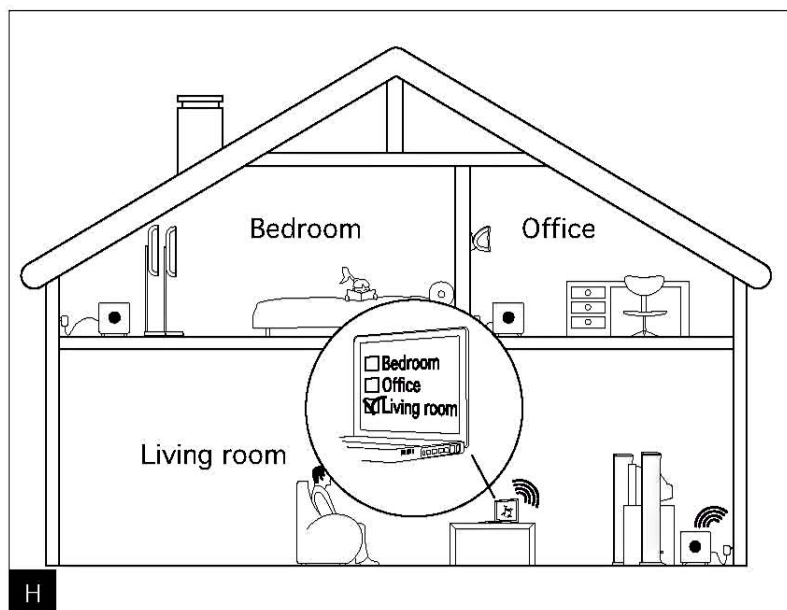
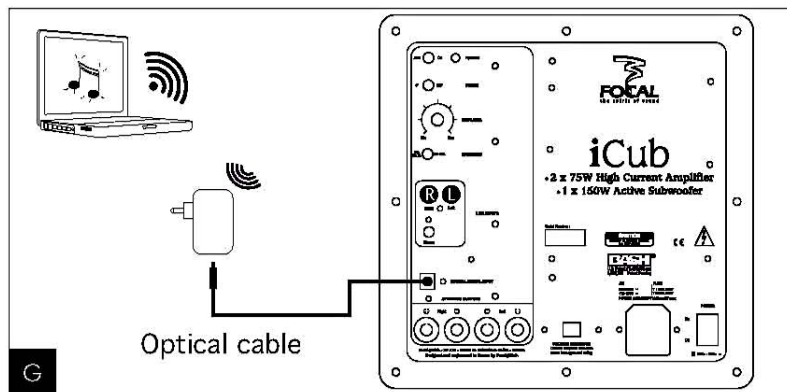

Create a multiroom Wi-Fi network

Several Airport Express equipped iCubs can be installed in different locations in the house. Software such as "Player" can permit you to activate or deactivate these stations as you move about your house.

Placement

While a traditional speaker should be away from walls and corners in the listening environment, we recommend that you place iCub in a corner (*fig I, J*).

If iCub is installed against a lone wall, or too distant from the walls, the very important long wavelengths will negatively excite the resonances of the listening room. The frequency response will not be linear and the bass quality will be adversely affected (*lack of bass, hollow sound, muddy bass, perceived low output, difficult or impossible cross-checking with other loudspeakers, etc.*).

Installing iCub in a corner, the room resonance will be affected in a more linear and predictable fashion. Not only will the perception of bass be optimal, but this positioning will permit an increase of bass output to +6dB (*fig. K*). If you cannot place the subwoofer in a corner or have other restrictions on its placement, attempt different locations in the room until you find the best compromise.

Generally speaking, the best location for the subwoofer is in the front of the listening room.

As the bass frequency band is not directional, bass is not in principle adversely affected in case there is an object or a piece of furniture between the subwoofer and the listening position.

Magnetic disturbance

The iCub generates a magnetic leak that may interfere with other sensitive household appliances. It is strongly advised not to place the iCub closer than 50cm (20") to your TV screen. Frame geometry as well as colours can be severely distorted by a magnetic field if the loudspeaker is placed too close to the cathode ray tube.

Generally, every sensitive elements (audio tapes, video tapes, magnetic data storages, projector and CRTS overhead-projector) should not be placed too close to non-shielded loudspeakers.

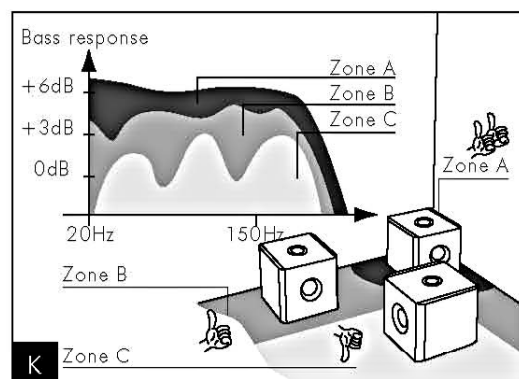
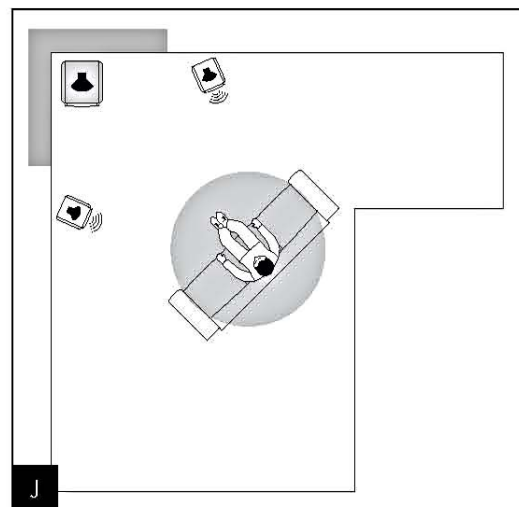
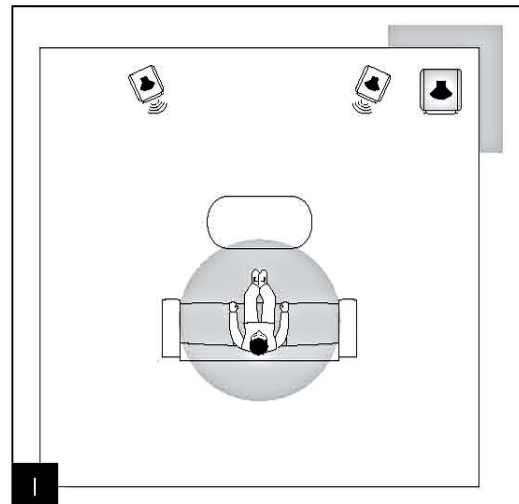

Getting started

Quick start

- 1 - Connect speakers to iCub.
- 2 - Connect a digital or analog source.
- 3 - Choose the correct setting for the switch "High pass."
- 4 - Turn the control "Sub level" to the half position.
- 5 - Connect the iCub to the AC current.
- 6 - Turn the power switch to "On".
- 7 - Adjust the motorized volume control on the top of iCub or by the remote control.
- 8 - Readjust the bass output to your liking via the "Sub level" control.
- 9 - Select the position on the phase inverter (0° or 180°).
The correct position is the one which provides the most and best-balanced bass.

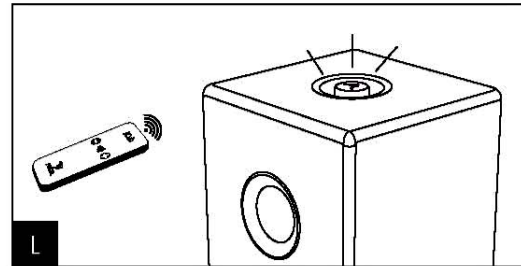

Auto turn on-delayed turn off

iCub is equipped with an automatic detection system. When the power switch is set to "Auto", the subwoofer will turn on immediately once a signal is detected at the input. On the "Power on" setting, the detector is inactive and the subwoofer is continually on. Yet if no signal is detected after several minutes, the detection circuit will automatically put the amp into standby.

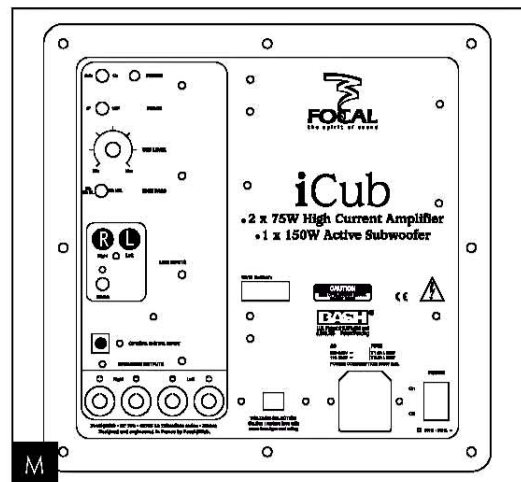

During an absence of several days or more, it is recommended to turn the power switch to "Off".

In case of an electrical storm, disconnect the unit from the AC outlet.

Running-in period

The driver used in the iCub is made up of complex mechanical elements and requires an adaptation period before it delivers the best of its performances. They must get adapted to the temperature and humidity conditions of their environment. This running-in period depends upon the encountered conditions and can last several weeks. In order to shorten this period, we advise you to let your subwoofer operate for about twenty hours at medium level, playing standard music programs, but with a large amount of bass. Once the components of the loudspeaker are completely stabilized, it is possible to enjoy the real performances of your self powered subwoofer.

Specifications

Description	2.1 control unit with bass-reflex subwoofer and three BASH® amplifiers, 400 Watts max. total
Speaker unit	8" (21cm)
L.F. (-6dB)	35Hz
Frequency response (+/-3dB)	40-110Hz
Crossover frequencies	Sib XXL setting: 85Hz Sib / Sib XL setting: 110Hz
Inputs	Stereo line on RCA Line stereo on 3.5mm mini-jack Digital optical (Toslink)
Nominal power handling	150 Wrms and 2 x 75 Wrms
Peak power	200 Watts max. and 2 x 100 Watts
Phase	switch 0° and 180°
Power settings	on / off / standby
Dimensions (HxWxD)	13.1" x 12" x 12" 333 mm x 300 mm x 300 mm
Weight	27.5 lb (12.5 kg)

Conditions of warranty

In the unlikely event of any problem, please contact your Focal-JMLab retailer. Outside of France, all Focal-JMLab speakers are covered by the guarantee drawn up by the official Focal-JMLab distributor in your country. Your distributor can provide all details concerning the conditions of guarantee. Guarantee cover extends at least the legal minimum period in force in the country where the original purchase invoice was issued.

Sib®, Sib XL®, Sib XXL® and iCub® are trademarks of Focal-JMLab®

iPod®, AirPort Express™, AirTunes®, iTunes™, Macintosh® are trademarks of Apple Computer Inc.

Focal-JMLab - BP374 - 108, rue de l'Avenir - 42353 La Talaudière cedex - France - www.focal-fr.com

Tel. 00 33 4 77 43 57 00 - Fax 00 33 4 77 43 57 04

Due to constant technological advances, Focal-JMLab reserves its right to modify specifications without notice. Images may not conform exactly to specific product.